

**Gebruiksaanwijzing en installatievoorschriften**

Inductiekookplaten Pro

**Mode d'emploi et d'installation**

Table à induction Pro

**Montage- und Bedienungsanleitung**

Induktions Kochfelder Pro

**Instructions for use and installation**

Pro induction hob

**1773-1 – 1774-1 – 1777-1 – 1778-1**

**NOVY®**

# SUMMARY

---

<b>SAFETY</b> .....	<b>64</b>
PRECAUTIONS BEFORE USING.....	64
USING THE APPLIANCE.....	65
PRECAUTIONS NOT TO DAMAGE THE APPLIANCE.....	66
PRECAUTIONS IN CASE OF APPLIANCE FAILURE.....	67
OTHER PROTECTIONS.....	67
<b>DESCRIPTION OF THE APPLIANCE</b> .....	<b>68</b>
TECHNICAL CHARACTERISTICS.....	68
IMPLEMENTATION POTS.....	68
CONTROL PANEL.....	68
<b>USE OF THE APPLIANCE</b> .....	<b>69</b>
DISPLAY.....	69
VENTILATION.....	69
<b>STARTING-UP AND APPLIANCE MANAGEMENT</b> .....	<b>70</b>
BEFORE THE FIRST USE.....	70
INDUCTION PRINCIPLE.....	70
SENSITIVE TOUCH.....	70
POWER SELECTION ZONE “SLIDER” AND TIMER SETTING ZONE.....	70
STARTING-UP.....	71
PAN DETECTION.....	71
RESIDUAL HEAT INDICATION.....	71
POWER AND SUPER POWER FUNCTION.....	71
TIMER.....	73
AUTOMATIC COOKING.....	74
STOP&GO FUNCTION.....	74
RECALL FUNCTION.....	74
“KEEP WARM” FUNCTION.....	75
BRIDGE AND AUTOMATIC BRIDGE FUNCTION.....	75
GRILL FUNCTION.....	75
CONTROL PANEL LOCKING.....	76
OPERATING TIME LIMITATION.....	76
<b>COOKING ADVICES</b> .....	<b>77</b>
PAN QUALITY.....	77
PAN DIMENSION.....	77
EXAMPLES OF COOKING POWER SETTING.....	78
<b>MAINTENANCE AND CLEANING</b> .....	<b>78</b>
<b>WHAT TO DO IN CASE OF A PROBLEM</b> .....	<b>78</b>
<b>ENVIRONMENT PRESERVATION</b> .....	<b>79</b>
<b>INSTALLATION INSTRUCTIONS</b> .....	<b>80</b>
<b>ELECTRICAL CONNECTION</b> .....	<b>81</b>

# SAFETY

---

## Precautions before using

- Unpack all the materials.
- The installation and connecting of the appliance have to be done by approved specialists. The manufacturer can not be responsible for damage caused by building-in or connecting errors.
- To be used, the appliance must be well-equipped and installed in a kitchen unit and an adapted and approved work surface.
- This domestic appliance is exclusively for the cooking of food, to the exclusion of any other domestic, commercial or industrial use.
- Remove all labels and self-adhesives from the ceramic glass.
- Do not change or alter the appliance.
- The cooking plate can not be used as freestanding or as working surface.
- The appliance must be grounded and connected conforming to local standards.
- Do not use any extension cable to connect it.
- The appliance can not be used above a dishwasher or a tumble-dryer: steam may damage the electronic appliances.
- The appliance is not intended to be operated by means of external timer or separate remote control system.

## Using the appliance

- Switch the heating zones off after using.
- Keep an eye on the cooking using grease or oils: that may quickly ignite.
- Be careful not to burn yourself while or after using the appliance.
- Make sure no cable of any fixed or moving appliance contacts with the glass or the hot saucepan.
- Magnetically objects (credit cards, floppy disks, calculators) should not be placed near to the engaged appliance.
- Metallic objects such as knives, forks, spoons and lids should not be placed on the hob surface since they can get hot.
- In general do not place any metallic object except heating containers on the glass surface. In case of untimely engaging or residual heat, this one may heat, melt or even burn.
- Never cover the appliance with a cloth or a protection sheet. This is supposed to become very hot and catch fire.
- This appliance can be used by children aged from 8 years and above and persons with reduced physical, sensory or mental capabilities or lack of experience and knowledge if they have been given supervision or instruction concerning use of the appliance in a safe way and understand the hazards involved.
- Children shall not play with the appliance.
- Cleaning and user maintenance shall not be made by children without supervision.

## Precautions not to damage the appliance

- Raw pan bottoms or damaged saucepans (not enamelled cast iron pots,) may damage the ceramic glass.
- Sand or other abrasive materials may damage ceramic glass.
- Avoid dropping objects, even little ones, on the vitroceramic.
- Do not hit the edges of the glass with saucepans.
- Make sure that the ventilation of the appliance works according to the manufacturer's instructions.
- Do not put or leave empty saucepans on the vitroceramic hobs.
- Sugar, synthetic materials or aluminium sheets must not contact with the heating zones. These may cause breaks or other alterations of the vitroceramic glass by cooling: switch on the appliance and take them immediately out of the hot heating zone (be careful: do not burn yourself).
- **WARNING:** Danger of fire: do not store items on the cooking surface.
- Never place any hot container over the control panel.
- If a drawer is situated under the embedded appliance, make sure the space between the content of the drawer and the inferior part of the appliance is large enough (2 cm). This is essential to guaranty a correct ventilation.
- Never put any inflammable object (ex. sprays) into the drawer situated under the vitroceramic hob. The eventual cutlery drawers must be resistant to heat.

## Precautions in case of appliance failure

- If a defect is noticed, switch on the appliance and turn off the electrical supplying.
- If the ceramic glass is cracked or fissured, you must unplug the appliance and contact the after sales service.
- Repairing has to be done by specialists. Do not open the appliance by yourself.
- **WARNING:** If the surface is cracked, switch off the appliance to avoid the possibility of electric shock.

## Other protections

- Note sure that the container pan is always centred on the cooking zone. The bottom of the pan must have to cover as much as possible the cooking zone.
- For the users of pacemaker, the magnetic field could influence its operating. We recommend getting information to the retailer or of the doctor.
- Do not to use aluminium or synthetic material containers: they could melt on still hot cooking zones.
- **NEVER** try to extinguish a fire with water, but switch off the appliance and then cover flame e.g. with a lid or a fire blanket.



**THE USE OF EITHER POOR QUALITY POT OR ANY  
INDUCTION ADAPTOR PLATE FOR NON-MAGNETIC  
COOKWARE RESULTS IN A WARRANTY BREACH.  
IN THIS CASE, THE MANUFACTURER CANNOT BE  
HELD RESPONSIBLE FOR ANY DAMAGE CAUSED TO  
THE HOB AND/OR ITS ENVIRONMENT.**



# DESCRIPTION OF THE APPLIANCE

## Technical characteristics

Type	1773-1 1777-1	1774-1	1778-1
Total power	7400 W	11100 W	11100 W
Energy consumption for the hob $EC_{hob}^{**}$	187.4 Wh/kg	188 Wh/kg	188 Wh/kg
<b>Heating zone</b>	220 x 180 mm	220 x 180 mm	220 x 180 mm
Minimum detection	Ø 100 mm	Ø 100 mm	Ø 100 mm
Nominal level*	2100 W	2100 W	2100 W
Power level*	2600 W	2600 W	2600 W
Super Power level*	3700 W	3700 W	3700 W
<b>Central heating zone</b>	-	-	Ø 260 mm
Minimum detection	-	-	Ø 90 / 220 mm
Nominal level*	-	-	1850 / 2600 W
Power level*	-	-	2500 / 3300 W
Super Power level*	-	-	3000 / 5500 W
Cookware **	Ø 150 mm	Ø 150 mm	Ø 150 mm
Energy consumption $EC_{cw}^{**}$	182.8 Wh/kg	182.8 Wh/kg	182.8 Wh/kg
Cookware **	Ø 180 mm	Ø 180 mm (x2)	Ø 180 mm (x2)
Energy consumption $EC_{cw}^{**}$	190.6 Wh/kg	190.6 Wh/kg	190.6 Wh/kg
Cookware **	Ø 210 mm (x2)	Ø 210 mm (x2)	Ø 210 mm (x2)
Energy consumption $EC_{cw}^{**}$	188.1 Wh/kg	188.1 Wh/kg	188.1 Wh/kg

\* The given power may change according to the dimensions and material of the pan.

\*\*Calculated according to the method of measuring performance (EN 60350-2).

## Implementation pots

Important: For optimal effect, it is important that the pan is centered on area heating zone (see diagram).

**1773-1**

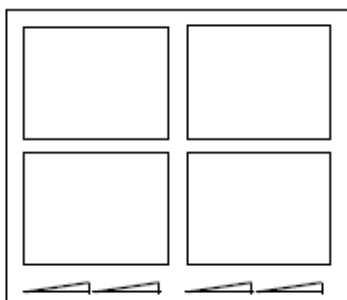

**1774-1**

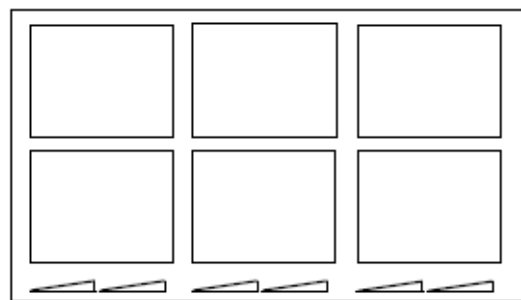

**1778-1**

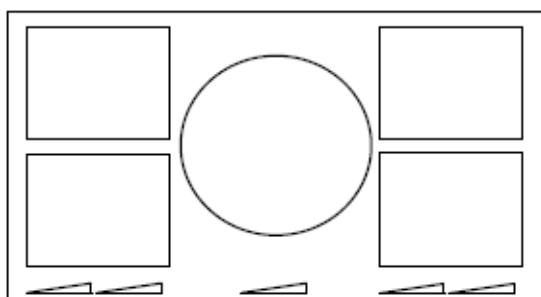

**1777-1**

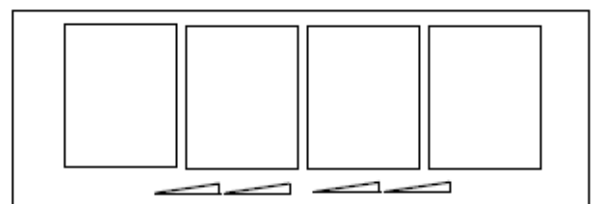

## Control panel

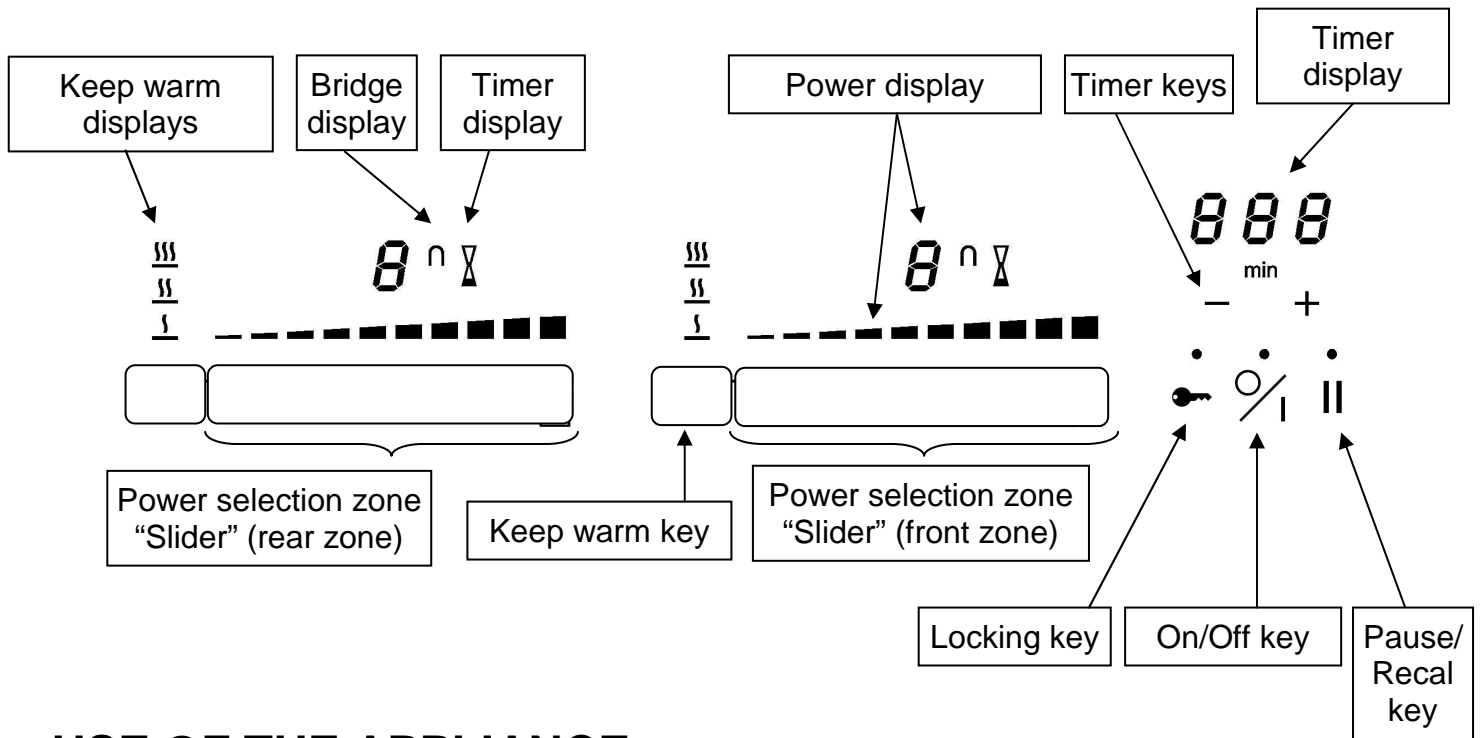

## USE OF THE APPLIANCE

### Display

Display	Designation	Description
0	Zero	The heating zone is activated.
1...9	Booster level	Selection of the cooking level.
<u>U</u>	No pan detection	No pan or inadequate pan.
A	Heat accelerator	Automatic cooking.
E	Error message	Electronic failure.
H	Residual heat	The heating zone is hot.
P	Power	The Power is activated.
„ //	Super Power	The Super power is activated.
U	Keep warm	Maintain automatically of 42, 70 or 94°C.
	Stop&Go	The hob is in pause.
□	Bridge	2 cooking zones are combined.

### Ventilation

The cooling system is fully automatic. The cooling fan starts with a low speed when the calories brought out by the electronic system reach a certain level. The ventilation starts his high speed when the hob is intensively used. The cooling fan reduces his speed and stops automatically when the electronic circuit is cooled enough.



# STARTING-UP AND APPLIANCE MANAGEMENT

---

## Before the first use

Clean your hob with a damp cloth, and then dry the surface thoroughly. Do not use detergent which risks causing blue-tinted colour on the glass surface.

## Induction principle

An induction coil is located under each heating zone. When it is engaged, it produces a variable electromagnetic field which produces inductive currents in the ferromagnetic bottom plate of the pan. The result is a heating-up of the pan located on the heating zone.

Of course the pan has to be adapted:

- All ferromagnetic pans are recommended (please verify it thanks a little magnet): cast iron and steel pans, enamelled pans, stainless-steel pans with ferromagnetic bottoms...
- Are excluded: copper, pure stainless-steel, aluminium, glass, wood, ceramic, stoneware,...

The induction heating zone adapts automatically the size of the pan. With a too small diameter the pan doesn't work. This diameter is varying in function of the heating zone diameter.

If the pan is not adapted to the induction hob the display will show [ U ].

## Sensitive touch

Your ceramic hob is equipped with electronic controls with sensitive touch keys. When your finger presses the key, the corresponding command is activated. This activation is validated by a control light, a letter or a number in the display and/or a "beep" sound.

**In the case of a general use press only one key at the same time.**

## Power selection zone "SLIDER" and timer setting zone

To select the power with the slider, slide your finger on the "SLIDER" zone. You can already have a direct access if you put your finger directly on the chosen level.

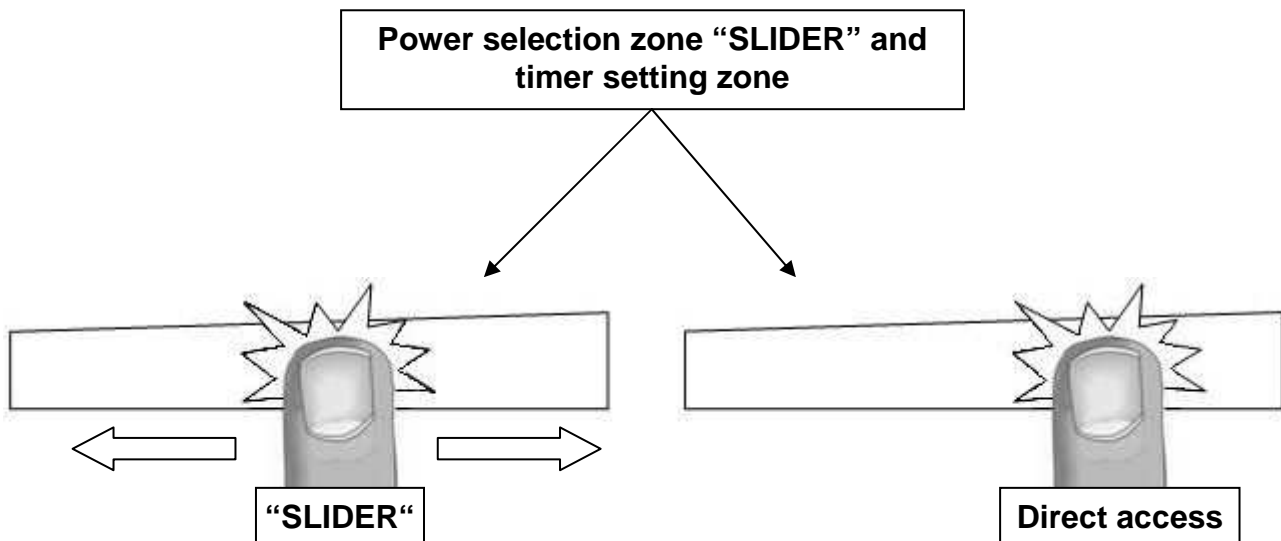

## Starting-up

- **Start up / switch off the hob:**

<u>Action</u>	<u>Control panel</u>	<u>Display</u>
To start	press key [0/I]	[ 0 ]
To stop	press key [0/I]	nothing or [ H ]

- **Start up / switch off a heating zone:**

<u>Action</u>	<u>Control panel</u>	<u>Display</u>
To set (adjust the power)	slide on the “SLIDER“ to the right or to the left	[ 1 ] to [ P ]
To stop	slide to [ 0 ] on “SLIDER“	[ 0 ] or [ H ]

If no action is made within 20 second the electronics returns in waiting position.

## Pan detection

The pan detection ensures a perfect safety. The induction doesn't work:

- If there is no pan on the heating zone or if this pan is not adapted to the induction. In this case it is impossible to increase the power and the display shows [ U ]. This symbol disappears when a pan is put on the heating zone.
- If the pan is removed from the heating zone the operation is stopped. The display shows [ U ]. The symbol [ U ] disappears when the pan is put back to the heating zone. The cooking continues with the power level set before.

After use, switch the heat element off: don't let the pan detection [ U ] active.

## Residual heat indication

After the switch off of a heating zone or the complete stop of the hob, the heating zones are still hot and indicates [ H ] on the display.

The symbol [ H ] disappears when the heating zones may be touched without danger.

As far as the residual heat indicators are on light, don't touch the heating zones and don't put any heat sensitive object on them. **There are risks of burn and fire.**

## Power and Super Power function

Power [ P ] and Super Power [ **!!** ] grant a boost of Power to the selected heating zone.

If this function is activated the heating zones work during 10 minutes with an ultra high Power.

This is foreseen for example to heat up rapidly big quantities of water, like nuddles

- **Start up / Stop the Power:**

<u>Action</u>	<u>Control panel</u>	<u>Display</u>
Start up the Power	Slide to the end of the “SLIDER“ Or press directly on the end of the “SLIDER“	[ P ]
Stop the Power	Slide on the “SLIDER“	[ 9 ] to [ 0 ]

- **Start up / Stop Super Power**

<b><u>Action</u></b>	<b><u>Control panel</u></b>	<b><u>Display</u></b>
Start up the Power	Slide to the end of the "SLIDER" Or press directly on the end of the "SLIDER"	[ P ]
Start up Super Power	Re-press key [ P ]	[ ,, // and P ]
Stop the Super Power	Slide on the "SLIDER"	[ P ] to [ 0 ]
Stop Power	Slide on the "SLIDER"	[ 9 ] to [ 0 ]

- **Power management:**

The table is divided in 3 separate sets of heating zones, each set having a maximum power.

**1773-1**

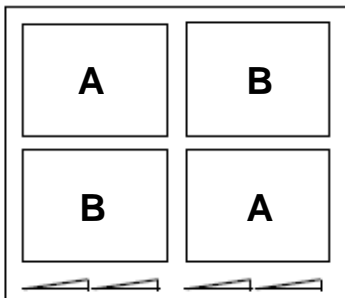

**1774-1**

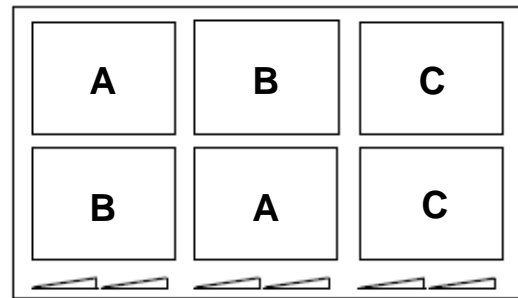

**1778-1**

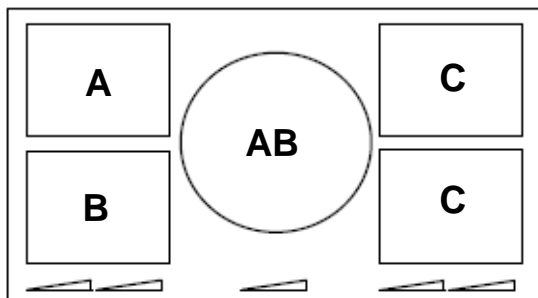

**1777-1**

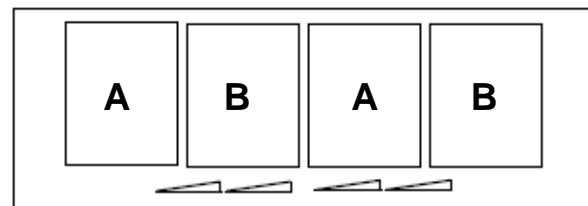

If the selected heating levels for both zones exceed the maximum available amount of power, the power management function is automatically reducing the power from one of these zones. The display of this zone is first blinking; the level is then automatically reduced to the highest suitable position.

**Heating zone selected**

[ P ] is displayed

**The other heating zone: (example: power level 9)**

[ 9 ] goes to [ 8 ] and blinks

It is possible to activate the booster function (or double booster) on several cooking zones at the same time, for this it is necessary to use the zones in a discriminant way (A-B, A-C, B-C or A-B-C).

## Timer

The timer is able to be used simultaneous with all heating zones and this with different time settings (from 0 to 999 minutes) for each heating zone.

- **Setting and modification of the cooking time:**

<b><u>Action</u></b>	<b><u>Control panel</u></b>	<b><u>Display</u></b>
Select the power level	slide on the "SLIDER"	[ 1 ] to [ P ]
Select the Timer	Press simultaneously key [ - ] and [ + ] from the timer until the desired display is on	Timer display on
Decrease the time	Press key [ - ] from the timer	[ 60 ] to 59, 58...
Increase the time	Press key [ + ] from the timer	Time increase

After a few seconds, the [ min ] display stops with blinking.

The time is confirmed and the timer starts.

- **To stop the cooking time:**

<b><u>Action</u></b>	<b><u>Control panel</u></b>	<b><u>Display</u></b>
Select the Timer	Press simultaneously key [ - ] and [ + ] from the timer until the desired display is on	Timer display on
Stop the time	Press key [ - ] from the timer	[ 000 ]

If several timers are activated, repeat the process.

- **Egg timer function:**

Egg timer is an independent function. It stops as soon as a heating zone starts up.

If the egg timer is on and the hob is switched off, the timer continues until time runs out.

<b><u>Action</u></b>	<b><u>Control panel</u></b>	<b><u>Display</u></b>
Activate the hob	press display [ 0/I ]	[ 0 ]
Select the Timer	Press simultaneously key [ - ] and [ + ] from the timer	[ 000 ]
Decrease the time	Press key [ - ] from the timer	[ 60 ] to 59, 58...
Increase the time	Press key [ + ] from the timer	Time increase

After a few seconds, the [ min ] display stops with blinking.

The time is confirmed and the timer starts.

- **Automatic stop at the end of the cooking time:**

As soon as the selected cooking time is finished the timer displays blinking [ 000 ] and a sound rings.

To stop the sound and the blinking, press the key [ - ] and [ + ].

## Automatic cooking

All the cooking zones are equipped with an automatic cooking device. The cooking zone starts at full power during a certain time, and then reduces automatically its power on the pre-selected level.

- **Start-up:**

<b><u>Action</u></b>	<b><u>Control panel</u></b>	<b><u>Display</u></b>
Power level selection (for example « 7 »)	slide on the “SLIDER” to [ 7 ] and stay 3s	[ 7 ] is blinking with [ A ]

- **Switching off the automatic cooking:**

<b><u>Action</u></b>	<b><u>Control panel</u></b>	<b><u>Display</u></b>
Power level selection	slide on the “SLIDER”	[ 0 ] to [ 9 ]

<b>Selected power</b>	<b>Automatic cooking time (Min:S)</b>
<b>1</b>	<b>00:40</b>
<b>2</b>	<b>01:12</b>
<b>3</b>	<b>02:00</b>
<b>4</b>	<b>02:56</b>
<b>5</b>	<b>04:16</b>
<b>6</b>	<b>07:12</b>
<b>7</b>	<b>02:00</b>
<b>8</b>	<b>03:12</b>
<b>9</b>	<b>- : -</b>

## Stop&Go function

This function brakes all the hob’s cooking activity temporarily and allows restarting with the same settings.

- **Start up/stop the pause function:**

<b><u>Action</u></b>	<b><u>Control panel</u></b>	<b><u>Display</u></b>
Engage pause	press [ II ]	[ II ] and control light on
Stop the pause	press [ II ] Press on the animated “slider”	“Slider” animated previous settings

## Recall Function

After switching off the hob ( 0/I ), it is possible to recall the last settings.

- cooking stages of all cooking zones (Booster)
- minutes and seconds of programmed cooking zone-related timers
- Keep warm function
- Automatic cooking

The recall procedure is following:



- Press the key [0/I]
- Then press [ II ] before the light stops blinking.

The previous settings are again active.

## “Keep warm” Function

This function allows the reach and automatically maintains at the temperature of 42, 70 or 94°C. This will avoid liquids overflowing and fast burning at the bottom of the pan.



- **To engage, to start the function « Keep warm »:**

<u>Action</u>	<u>Control panel</u>	<u>Display</u>
42°C to engage	Press once on key [Keep warm ]	[ U ] and [  ]
70°C to engage	Press twice on key [Keep warm ]	[ U ] and [  ]
94°C to engage	Press 3 times on key [Keep warm ]	[ U ] and [  ]
To stop	Slide on the “SLIDER“ or press key [Keep warm ] until [ 0 ]	[ 0 ] to [ 9 ] [ 0 ]

The maximum duration of keeping warm is 2 hours.



## Bridge and automatic Bridge Function

This function allows the use of 2 cooking zones at the same time with the same features as a single cooking zone. With this function the Booster function is allowed on the left and center zones.

<u>Action</u>	<u>Control panel</u>	<u>Display</u>
Activate the hob	Press display [ 0/I ]	[ 0 ]
Activate the bridge	Press simultaneously on [Keep warm ] of the 2 cooking zones or put a great pan on the 2 zones and press on the 2 “SLIDER“	[ 0 ] and [  ]
Increase bridge	Slide on the “SLIDER“ witch indicates the power	[  ] blink [  ]
Stop the bridge	Press simultaneously on [Keep warm ] of the 2 cooking zones	[ 1 ] to [ 9 ] [ 0 ]



## Grill Function

This function allows the optimal use of the grill plate with combining two areas and using appropriate powers.

<u>Action</u>	<u>Control panel</u>	<u>Display</u>
Activate the hob	Press display [ 0/I ] put the grill plate on the 2 zones to use	[ 0 ] [  ] blink
Activate the Grill	Press simultaneously on the « SLIDER » of the 2 cooking zones	[  ]
Increase the Grill	Slide on the “SLIDER“ witch indicates the power	power level on the slider
Stop the Grill	Press simultaneously on the « SLIDER » of the 2 cooking zones	[ 0 ]

## Control panel locking

To avoid modification of the setting of the cooking zones , in particular during cleaning, the control panel can be locked (with exception to the On/Off key [ 0/I ]).

<u>Action</u>	<u>Control panel</u>	<u>Display</u>
Locking the hob	Press [  ] during 6s	locking light on
Unlock the hob	Press [  ] during 6s	locking light off

## Operating time limitation

Each cooking zone is equipped with an operating time limitation: the cooking zone is automatically switched off after a certain time without any change of settings. This time is varying according to the selected power level as described in the table below.

<b>Power level</b>	<b>Operating time (H : Min)</b>
<b>1</b>	<b>08:36</b>
<b>2</b>	<b>06:42</b>
<b>3</b>	<b>05:18</b>
<b>4</b>	<b>04:18</b>
<b>5</b>	<b>03:30</b>
<b>6</b>	<b>02:18</b>
<b>7</b>	<b>02:18</b>
<b>8</b>	<b>01:48</b>
<b>9</b>	<b>01:30</b>
<b>Power</b>	<b>00:10</b>
<b>Super Power</b>	<b>00:10</b>

# COOKING ADVICES

---

## Pan quality

**Adapted materials:** steel, enamelled steel, cast iron, ferromagnetic stainless-steel, aluminium with ferromagnetic bottom.

**Not adapted materials:** aluminium and stainless-steel without ferromagnetic bottom, copper, brass, glass, ceramic, porcelain.

The manufacturers specify if their products are compatible induction.

To check if pans are compatibles:

- Put a little water in a pan placed on an induction heating zone set at level [ 9 ]. This water must heat in a few seconds.
- A magnet sticks on the bottom of the pan.

Certain pans can make noise when they are placed on an induction cooking zone. This noise doesn't mean any failure on the appliance and doesn't influence the cooking operating.

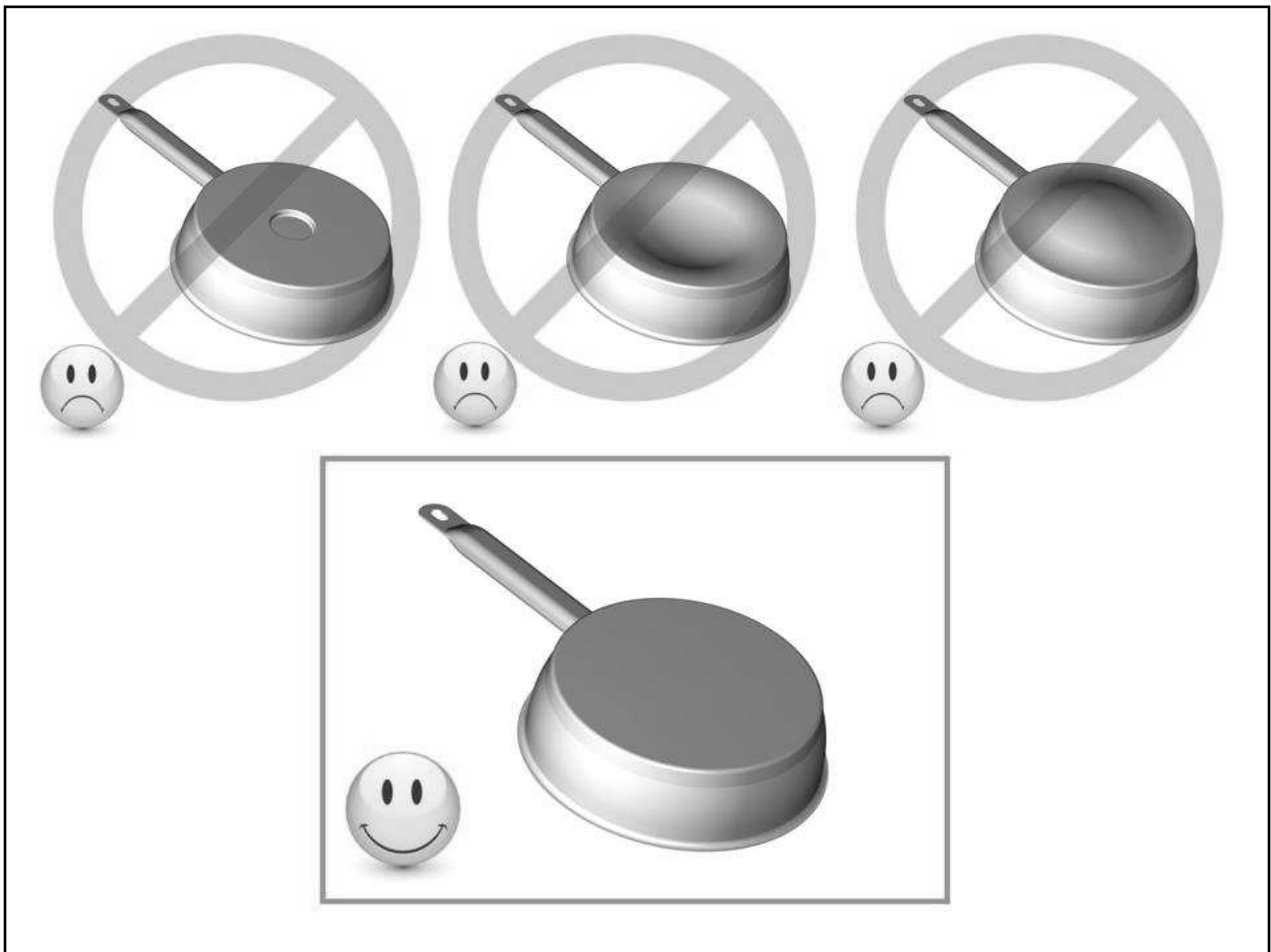

## Pan dimension

The cooking zones are, until a certain limit, automatically adapted to the diameter of the pan. However the bottom of this pan must have a minimum of diameter according to the corresponding cooking zone.

To obtain the best efficiency of your hob, please place the pan well in the centre of the cooking zone.



## Examples of cooking power setting

(the values below are indicative)

1 to 2	Melting Reheating	Sauces, butter, chocolate, gelatine Dishes prepared beforehand
2 to 3	Simmering Defrosting	Rice, pudding, sugar syrup Dried vegetables, fish, frozen products
3 to 4	Steam	Vegetables, fish, meat
4 to 5	Water	Steamed potatoes, soups, pasta, fresh vegetables
6 to 7	Medium cooking Simmering	Meat, lever, eggs, sausages Goulash, roulade, tripe
7 to 8	Cooking	Potatoes, fritters, wafers
9	Frying, roasting Boiling water	Steaks, omelettes, fried dishes Water
P and <b>  </b>	Frying, roasting Boiling water	scallops, steaks Boiling significant quantities of water

## MAINTENANCE AND CLEANING

---

### Switch-off the appliance before cleaning.

Do not clean the hob if the glass is too hot because they are **risk of burn**.

- Remove light marks with a damp cloth with washing up liquid diluted in a little water. Then rinse with cold water and dry the surface thoroughly.
- Highly corrosive or abrasive detergents and cleaning equipment likely to cause scratches must be absolutely avoided.
- Do not ever use any steam-cleaner or pressure washer
- Do not use any object that may scratch the ceramic glass.
- Ensure that the pan is dry and clean. Ensure that there are no grains of dust on your ceramic hob or on the pan. Sliding rough saucepans will scratch the surface.
- Spillages of sugar, jam, jelly, etc. must be removed immediately. You will thus prevent the surface being damaged.

## WHAT TO DO IN CASE OF A PROBLEM

---

### The hob or the cooking zone doesn't start-up:

- The hob is badly connected on the electrical network.
- The protection fuse cut-off.
- The locking function is activated.
- The sensitive keys are covered of grease or water.
- An object is put on a key.

### The control panel displays [ U ]:

- There is no pan on the cooking zone.
- The pan is not compatible with induction.
- The bottom diameter of the pan is too small.

### **The control panel displays [ E ]:**

- The electronic system is defective.
- Disconnect and replug the hob.
- Call after sales

### **One or all cooking zone cut-off:**

- The safety system functioned.
- You forgot to cut-off the cooking zone for a long time.
- One or more sensitive keys are covered.
- The pan is empty and its bottom overheated.
- The hob also has an automatic reduction of Booster level and breaking Automatic overheating

### **Continuous ventilation after cutting off the hob:**

- This is not a failure, the fan continuous to protect the electronic device.
- The fan cooling stops automatically.

### **The automatic cooking system doesn't start-up:**

- The cooking zone is still hot [ H ].
- The highest Booster level is set [ 9 ].

### **The control panel displays [ U ]:**

- Refer to the chapter "Keep warm".

### **The control panel displays [ II ]:**

- Refer to the chapter "Stop&Go"

### **The control panel displays [ ] or [ Er03 ]:**

- An object or liquid covers the control keys. The symbol disappear as soon as the key is released or cleaned.

### **The control panel displays [ E2 ]:**

- The hob is overheated, let it cool and then turn it on again.

### **The control panel displays [ E8 ]:**

- The air inlet of the ventilator is obstructed, release it.

### **The control panel displays [ U400 ]:**

- The hob is not connected to the network. Check the connection and reconnect the hob.

### **The control panel displays [ Er47 ]:**

- The hob is not connected to the network. Check the connection and reconnect the hob.

**If one of the symbols above persists, call the SAV.**

## **ENVIRONMENT PRESERVATION**

---

- The materials of packing are ecological and recyclable.
- The electronic appliances are composed of recyclable, and sometimes harmful materials for the environment, but necessary to the good running and the safety of the appliance.

- Don't throw your appliance with the household refuses
  - Get in touch with the waste collection centre of your commune that is adapted to the recycling of the household appliances.

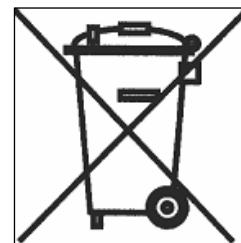

# INSTALLATION INSTRUCTIONS

The installation comes under the exclusive responsibility of specialists.  
The installer is held to respect the legislation and the standards enforce in his home country.

## How to stick the gasket:

The gasket supplied with the hob avoids all infiltration of liquids in the cabinet.  
His installation has to be done carefully, in conformity of the following drawing.

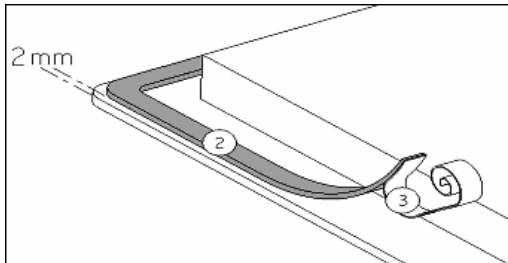

Stick the gasket (2) two millimeters from the external edge of the glass, after removing the protection sheet (3).

## Fitting - installing:

- The cut out sizes are:

Type	Cut size		Glass size			Cut size of flush mouting		
	Width	Depth	Width	Depth	Thickness	Width	Depth	Radius
1773-1	560	490	596	526	8	590	520	4
1774-1	750	490	786	526	8	780	520	4
1777-1	890	390	916	416	8	910	410	4
1778-1	810	490	886	526	8	880	520	4

- Ensure that there is a distance of 50 mm between the hob and the wall or sides.
- The hobs are classified as “Y” class for heat protection. Ideally the hob should be installed with plenty of space on either side. There may be a wall at the rear and tall units or a wall at one side. **On the other side, however, no unit or divider must stand higher than the hob.**
- The piece of furniture or the support in which the hob is to be fitted, as well as the edges of furniture, the laminate coatings and the glue used to fix them, must be able to resist temperatures of up to 100 °C.
- The mural rods of edge must be heat-resisting.
- Not to install the hob to the top of a not ventilated oven or a dishwasher.
- To guarantee under the bottom of the hob casing a space of 20 mm to ensure a good air circulation of the electronic device.
- If a drawer is placed under the work, avoid to put into this drawer flammable objects (for example: sprays) or not heat-resistant objects.
- Materials which are often used to make worktops expand on contact with water. To protect the cut out edge, apply a coat of varnish or special sealant. Particular care must be given to applying the adhesive joint supplied with the hob to prevent any leakage into the supporting furniture. This gasket guaranties a correct seal when used in conjunction with smooth work top surfaces.
- The safety gap between the hob and the cooker hood placed above must respect the indications of the hood manufacturer. In case of absence of instructions respect a distance minimum of 760 mm.
- The connection cord should be subjected, after building, with no mechanical constraint, such for example of the fact of the drawer.

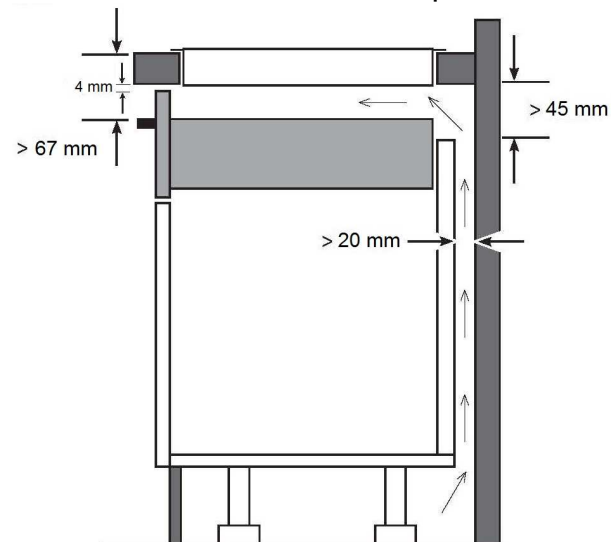

- **WARNING:** Use only hob guards designed by the manufacturer of the cooking appliance or indicated by the manufacturer of the appliance in the instructions for use as suitable or hob guards incorporated in the appliance. The use of inappropriate guards can cause accidents.

## ELECTRICAL CONNECTION

- The installation of this appliance and the connection to the electrical network should be entrusted only to an electrician perfectly to the fact of the normative regulations and which respects them scrupulously.
- Protection against the parts under tension must be ensured after the building-in.
- The data of connection necessary are on the stickers place on the hob casing near the connection box.
- The connection to the main must be made using an earthed plug or via an omnipolar circuit breaking device with a contact opening of at least 3 mm.
- The electrical circuit must be separated from the network by adapted devices, for example: circuit breakers, fuses or contactors.
- If the appliance is not fitted with an accessible plug, disconnecting means must be incorporated in the fixed installation, in accordance with the installation regulations.
- The inlet hose must be positioned so that it does not touch any of the hot parts of the hob or oven.

### Caution!

This appliance has only to be connected to a network 230 V~ 50/60 Hz.

Connect always the earth wire.

Respect the connection diagram.

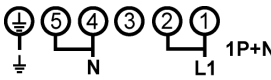
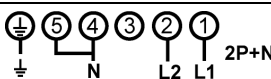
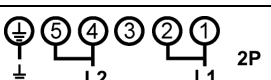
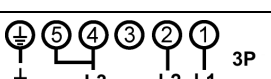

The connection box is located underneath at the back of the hob casing. To open the cover use a medium screwdriver. Place it in the slits and open the cover.

### CONNECTION OF THE HOB FOR 1773-1 – 1777-1

Mains	Connection	Supply cord	Supply cord	Wiring diagram	Circuit braker
230 V~ 50/60 Hz	1 phase +N	3 x 2,5 mm <sup>2</sup>	H 05 VV - F H 05 RR - F		25 A *
400 V~ 50/60Hz	2 phases + N	4 x 1,5 mm <sup>2</sup>	H 05 VV - F H 05 RR - F		16 A *
230 V~ 50/60 Hz	2 phases	3 x 2,5 mm <sup>2</sup>	H 05 VV - F H 05 RR - F		25 A *
230 V~ 50/60 Hz	3 phases	4 x 1,5 mm <sup>2</sup>	H 05 VV - F H 05 RR - F		16 A *

\* calculated with the simultaneous factor following the standard EN 60 335-2-6

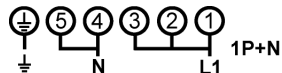
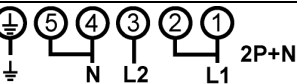
## CONNECTION OF THE HOB FOR 1774-1 – 1778-1

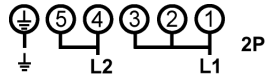
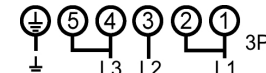
Mains	Connection	Supply cord	Supply cord	Wiring diagram	Circuit braken
230 V~ 50/60 Hz	1 phase +N	3 x 4 mm <sup>2</sup>	H 05 VV - F H 05 RR - F		40 A *
400 V~ 50/60Hz	2 phases + N	4 x 2,5 mm <sup>2</sup>	H 05 VV - F H 05 RR - F		25 A *
400 V~ 50/60Hz	3 phases + N	5 x 1,5 mm <sup>2</sup>	H 05 VV - F H 05 RR - F		16 A *
230 V~ 50/60 Hz	2 phases	3 x 4 mm <sup>2</sup>	H 05 VV - F H 05 RR - F		40 A *
230 V~ 50/60 Hz	3 phases	4 x 2,5 mm <sup>2</sup>	H 05 VV - F H 05 RR - F		25 A *

\* calculated with the simultaneous factor following the standard EN 60 335-2-6

**Caution! Be careful that the cables are correctly engaged and tightened.**

**We cannot be held responsible for any incident resulting from incorrect connection or which could arise from the use of an appliance which has not been earthed or has been equipped with a faulty earth connection.**



